

# OEM DRAPING SOLUTIONS FOR KITS & TRAYS

---

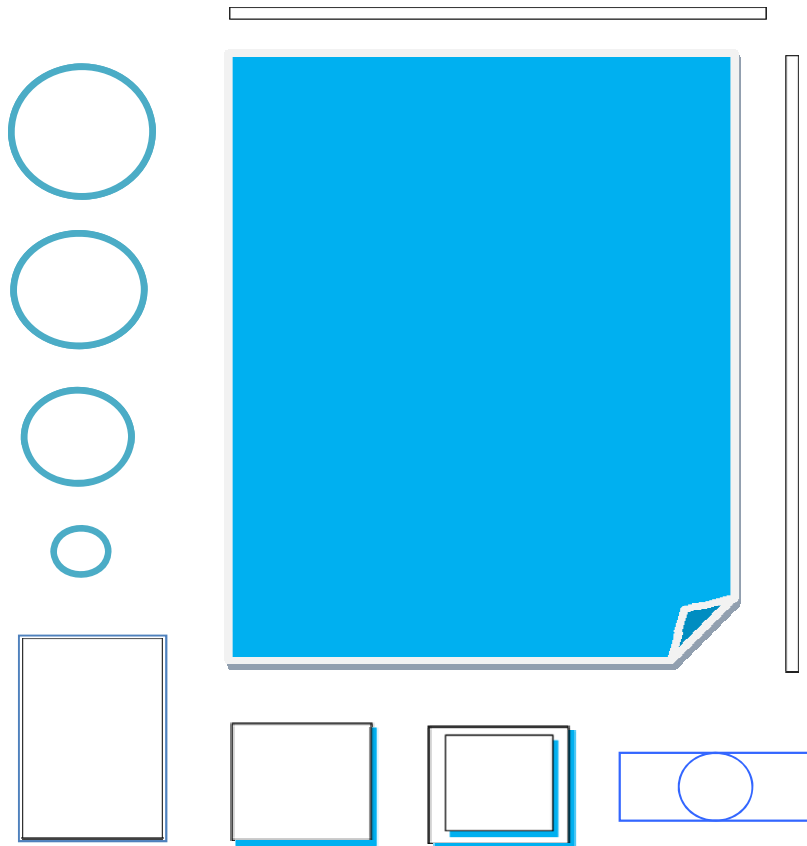

**Busse Hospital Disposables**

Date October 7th, 2009

Volume 1, Issue 1, Rev C

*Drape Manual*

## TABLE OF CONTENTS

---

---

<b>Drape Styles</b>	
<i>Standard Drape Photos</i>	3
<i>Non - Fenestrated Drapes</i>	4 - 8
<i>Fenestrated Drapes</i>	9 - 10
<i>Fenestrated Drapes with Adhesive Patch</i>	11 - 13
<i>Fenestrated Drapes with Adhesive Strip or Labels</i>	14 - 16
<i>U - Drape</i>	17
<i>Standard Drape List</i>	18 - 20

---

---

<b>Performance &amp; Regulatory Information</b>	
<i>AAMI Barrier Protection Classification</i>	21
<i>Barrier Protection Critical Zone Explanation</i>	22
<i>Flammability Compliance</i>	22
<i>Biocompatibility Summary Report</i>	23
<i>Material Safety Data Sheet</i>	24
<i>Kit Manufacturer Questionnaire</i>	25 - 27

---

---

<b>Build-a-Drape</b>	
<i>Material Selection</i>	28
<i>Fenestration Selection Page</i>	29
<i>Adhesive Strip</i>	30
<i>Adhesive Label</i>	31
<i>Fold Style</i>	32 - 33
<i>Machine Capability Template</i>	34 - 36
<i>Build-a-Drape Worksheet</i>	37
<i>Code Matrix - For Busse Internal Use</i>	38 - 39

---

---

<b>Contact Information</b>	
<i>Call in Information</i>	41

Standard Drape Photos



Cat # 6830 & 6840  
Bulk Non-Sterile



↑  
Unfolded Drape



Cat # 6598  
Bulk Non-Sterile



Cat # 6870  
Bulk Non-Sterile



Cat # 6700  
Bulk Non-Sterile



Cat # 6725  
Bulk Non-Sterile



Cat # 6861  
Bulk Non-Sterile



Cat # 6715  
Bulk Non-Sterile



Cat # 6850  
Bulk Non-Sterile

# Non-Fenestrated Drapes

Suggested use: Minor Procedure / General Surgery / OR

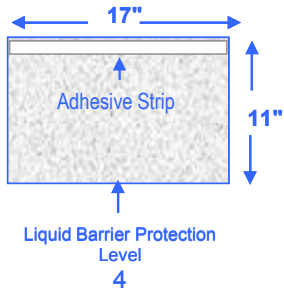

## Catalog Number: 6830

Material: Polyethylene Plastic, 1.5 mil  
 Color: Translucent - Matt Finish  
 Fold Style: Fan Fold

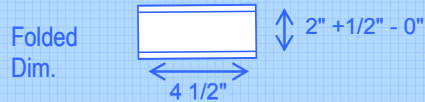

Packaging:  
 200 pcs/ Shipper Carton

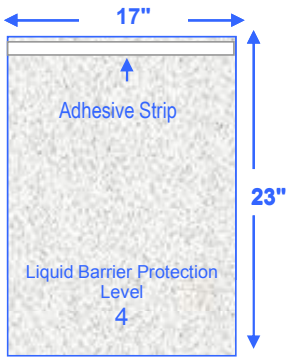
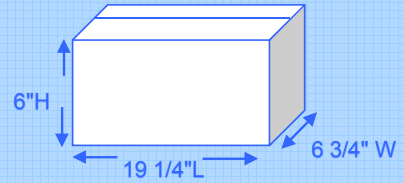

## Catalog Number: 6840

Material: Polyethylene Plastic, 1.5 mil  
 Color: Translucent - Matt Finish  
 Fold Style: Fan Fold

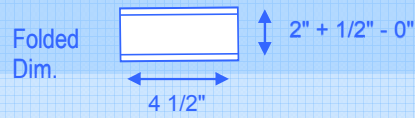

Packaging:  
 200 pcs./ Shipper Carton

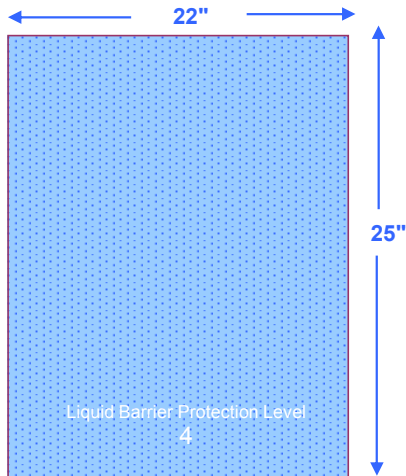
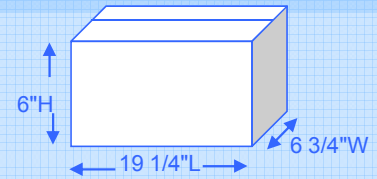

## Catalog Number: 6861

Material: Laminated Non Woven  
 Color: Blue  
 Fold Style: Z

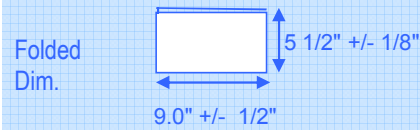

Packaging:  
 500 pcs. /Shipper Carton

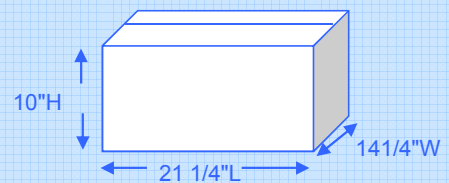

# Non-Fenestrated Drapes

Suggested use: Minor Procedure/ General Surgery / OR

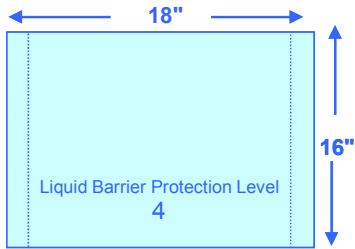

## Catalog Number: 7114

Material: Blue Tissue - Clear Polyethylene -WhiteTissue  
 Color: Blue / White  
 Fold Style: W

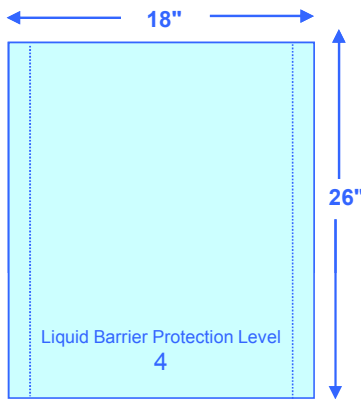
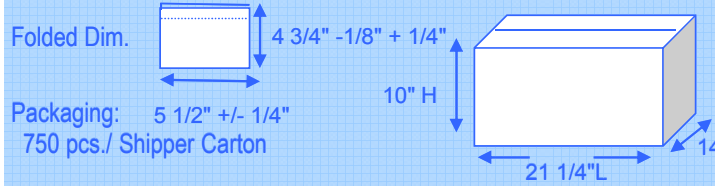

## Catalog Number: 6980

Material: Blue Tissue-Clear Polyethylene -WhiteTissue  
 Color: Blue / White  
 Fold Style: W

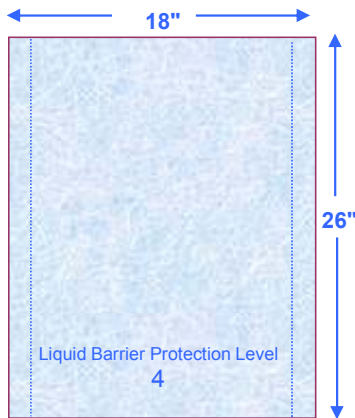
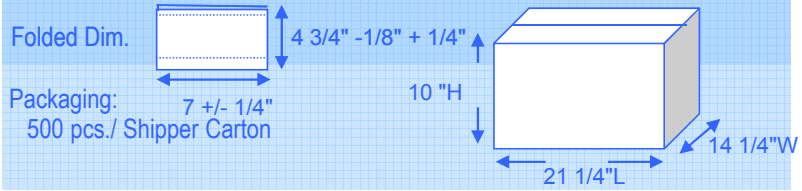

## Catalog Number: 695

Material: WhiteTissue-Blue Polypropylene -White Tissue  
 Color: White /Blue / White  
 Fold Style: W

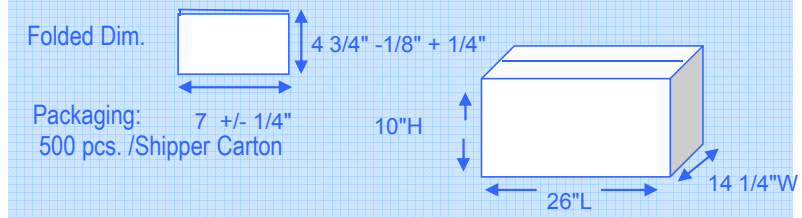

# Non-Fenestrated Drapes

Suggested use: Minor Procedure/ General Surgery / OR

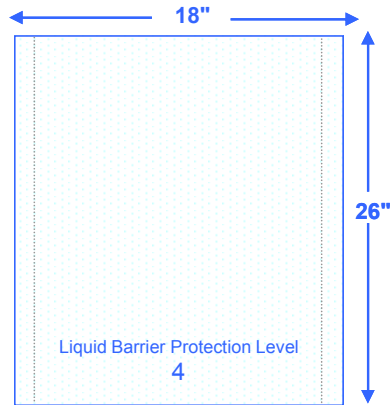

## Catalog Number: 6960

Material: White Tissue-Clear Polyethylene -WhiteTissue  
 Color: White  
 Fold Style: W

Folded Dim.

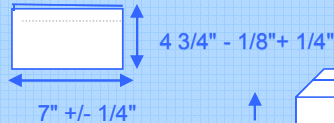

Packaging:  
 500 pcs/ Shipper Carton

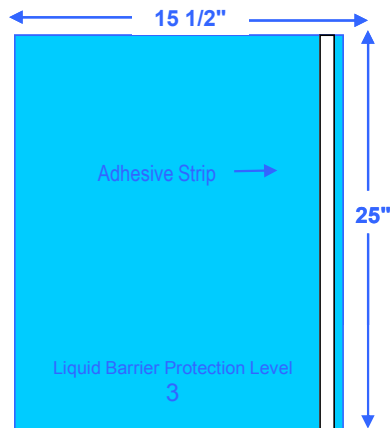
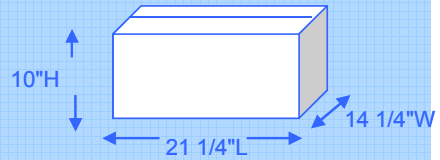

## Catalog Number: 6815

Material: Non absorbent-Non Woven - SMS-Strip Adhesive w/Paper  
 Release Liner  
 Color: Blue  
 Fold Style: W

Folded Dim.

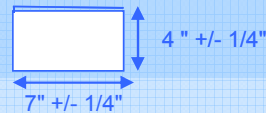

Packaging:  
 500 pcs/ Shipper Carton

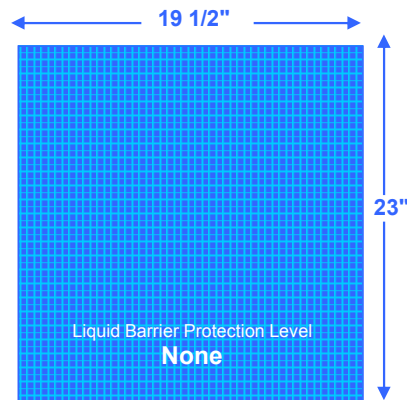
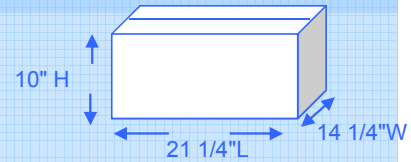

## Catalog Number: 6710 & 6711

Material: Absorbent Kaycel- Scrim Reinforced  
 Color: Blue  
 Fold Style: W

Folded Dim.

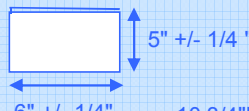

Packaging:  
 6710 - 200 pcs /Shipper Carton  
 6711 - 500 pcs /Shipper Carton

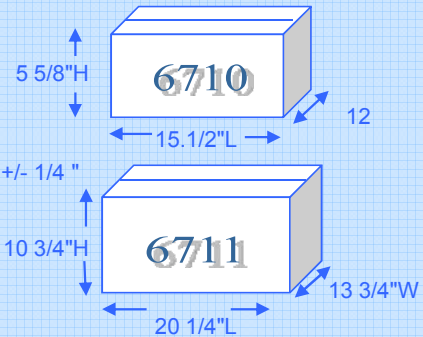

# Non-Fenestrated Drapes

Suggested use: Minor Procedure/ General Surgery / OR

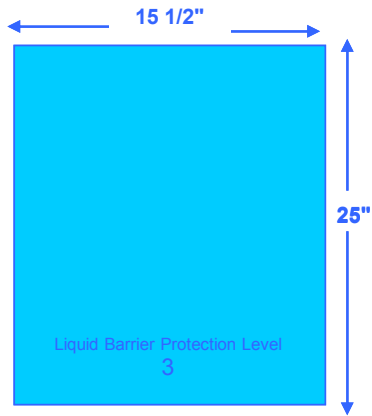

## Catalog Number: 6808

Material: Non absorbent-Non Woven - SMS  
Color: Blue  
Fold Style: W

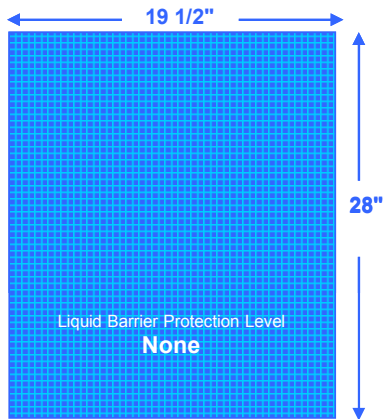
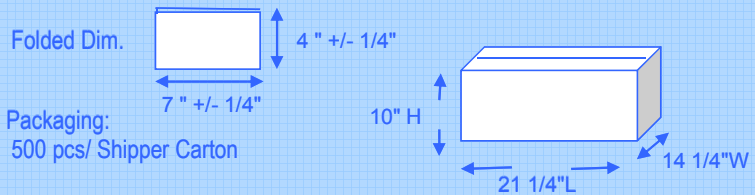

## Catalog Number: 6935

Material: Absorbent Kaycel - Scrim Reinforced  
Color: Blue  
Fold Style: W

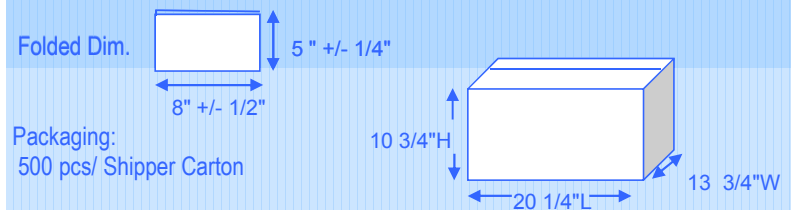

Suggested use: Ophthalmology

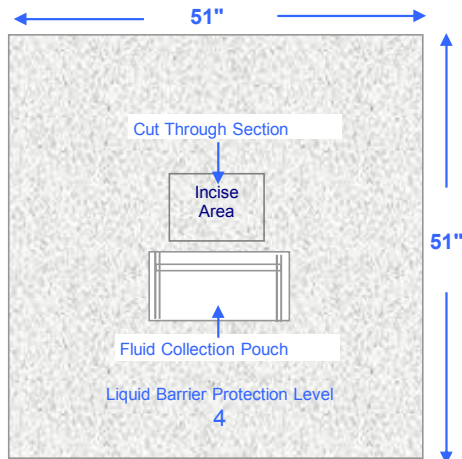

## Catalog Number: 6890

Material: Polyethylene Plastic 50 GSM  
Color: Translucent - Matt Finish

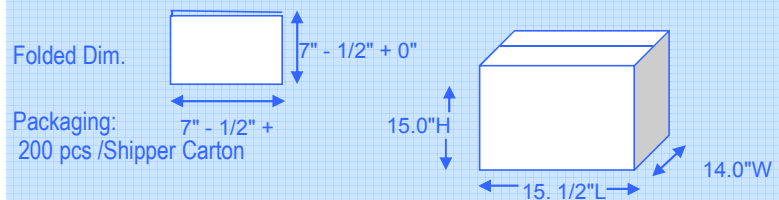

# Non-Fenestrated Drapes

Suggested use: Minor Procedure/ General Surgery / OR

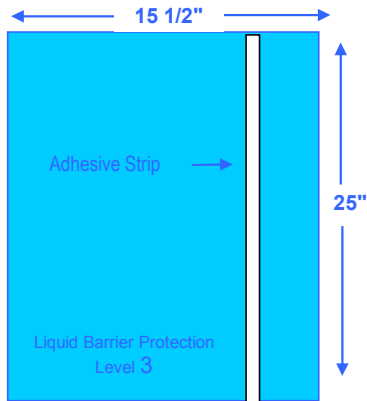

## Catalog Number: 6820

Material: Non absorbent-Non Woven - SMS-Strip Adhesive w/Paper  
Release Liner  
Color: Blue  
Fold Style: W

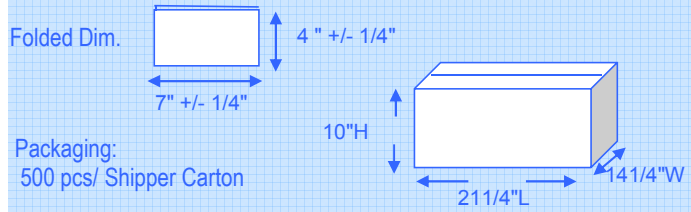



# Fenestrated Drapes

Suggested use: Minor Procedure/ General Surgery / OR

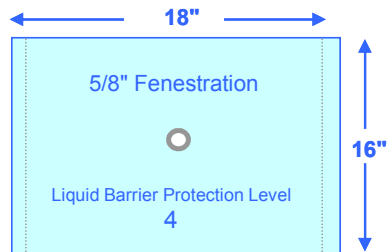

## Catalog Number: 3860A

Material: Blue Tissue-Clear Polyethylene -White Tissue  
 Color: Blue/ White  
 Fold Style: W

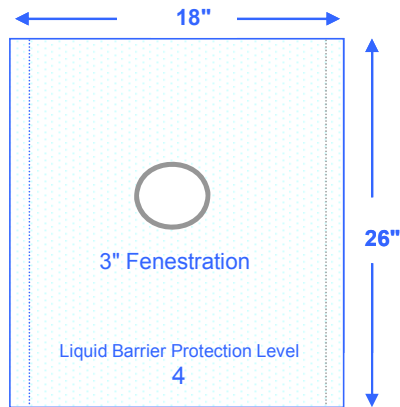
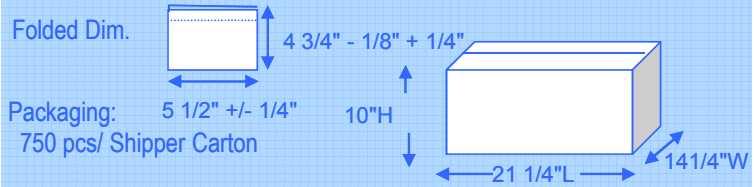

## Catalog Number: 6970

Material: White Tissue-ClearPoly -White Tissue  
 Color: White  
 Fold Style: W

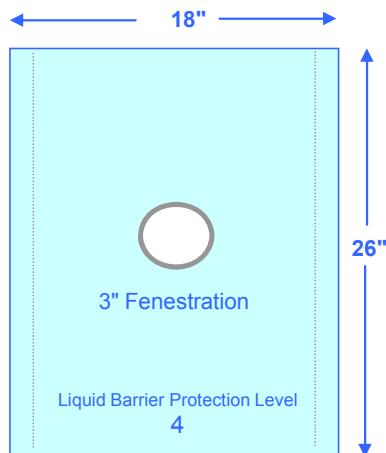
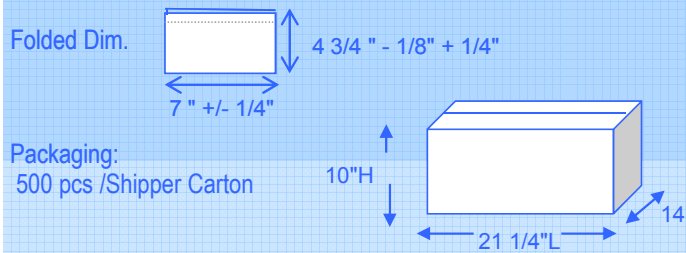

## Catalog Number: 694

Material: White Tissue-Blue Polypropylene -White Tissue  
 Color: White -Blue - White  
 Fold Style: W

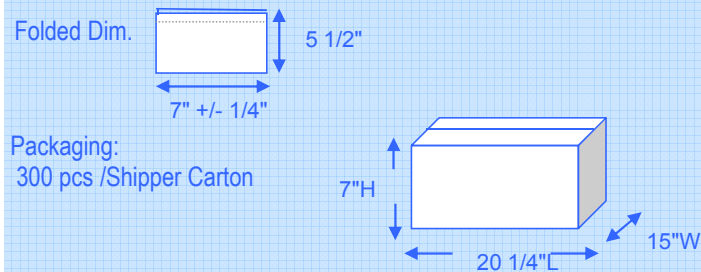

# Fenestrated Drapes

Suggested use: Minor Procedure/ General Surgery / OR

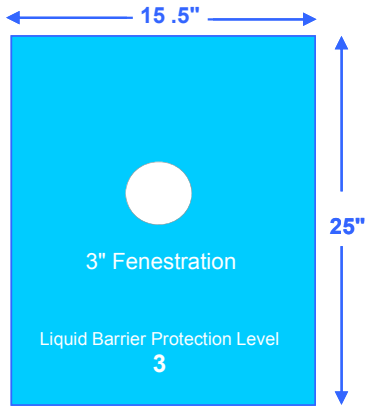

## Catalog Number: 6811

Material: Non absorbent-Non Woven - SMS  
 Color: Blue  
 Fold Style: W

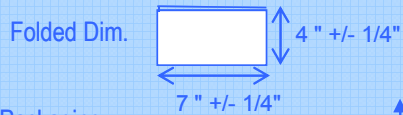

Packaging:  
 500 pcs/ Shipper Carton

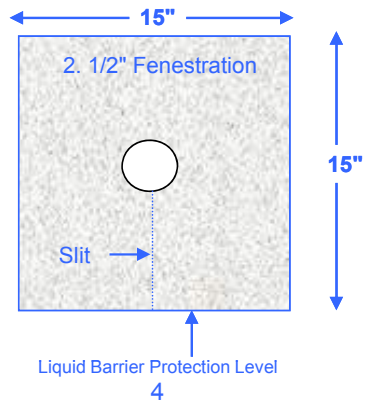
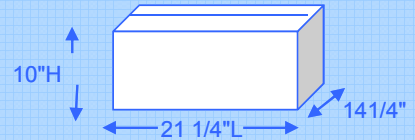

## Catalog Number: 6855

Material: Polyethylene Plastic, 1.5 Mil  
 Color: Translucent - Matt Finish  
 Fold Style: C

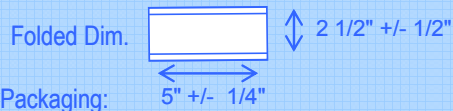

Packaging:  
 200 pcs/ Shipper Carton

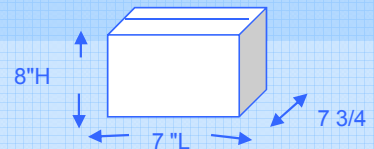

# FENESTRATED DRAPES WITH ADHESIVE PATCH

**Suggested use: Ophthalmology**

**Catalog Number: 6850**

Material: Plastic 1.5 mil /  
Adhesive/ Plastic Release Liner  
Color: Translucent - Matt Finish  
Fold Style: C

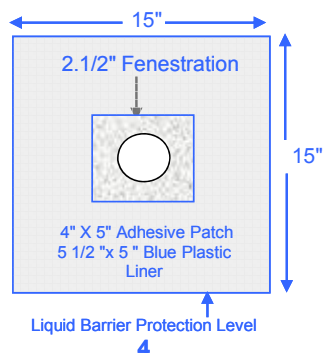

Folded: 2 1/2" +/- 1/2" height, 5" +/- 1/4" width.  
Packaging: 200 pcs./ Shipper Carton

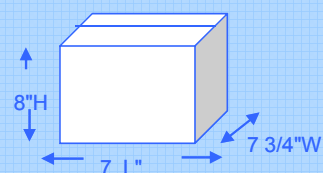

**Suggested use: Minor Procedure/ General Surgery / OR**

**Catalog Number: 6598**

Material: White Tissue - ClearPoly-White Tissue  
Adhesive -Paper Release Liner  
Color: White  
Fold Style: C

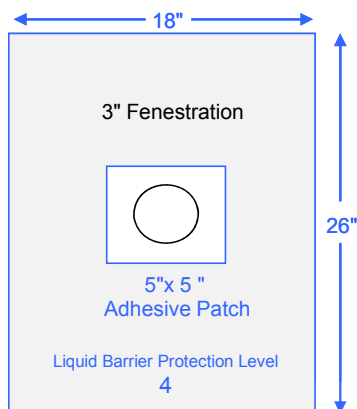

Fold Dim.: 6" +/- 1/2" height, 9" +/- 1/2" width.  
Packaging: 500 pcs./ Shipper Carton

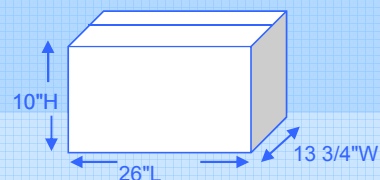

**Suggested use: Minor Procedure/ General Surgery / OR**

**Catalog Number: 6870**

Material: Laminated Non-Woven  
Adhesive/Paper Release Liner  
Color: Blue  
Fold Style: Z

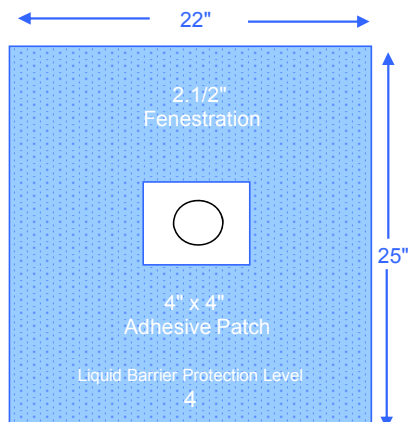

Folded Dim.: 5 1/2" +/- 1/2" height, 9" +/- 1/2" width.  
Packaging: 500 pcs. / Shipper Carton

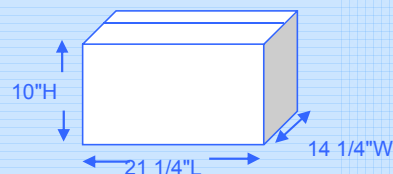

# Fenestrated Drapes with Adhesive Patch



Suggested use: Minor Procedure/ General Surgery / OR/ Pain Management

## Catalog Number: 6825

Material: SMS - Adhesive/Paper Release Liner  
 Color: Blue  
 Fold Style: C

26"

Folded Dim.

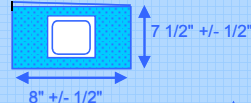

Packing: 250 pcs/ Shipper Carton

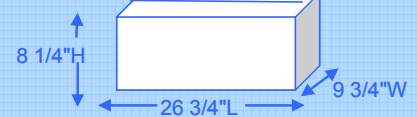

Suggested use: Pain Management Procedure

## Catalog Number: 6740

Material: Polyethylene Plastic 2.5 mil - Adhesive Fen /Paper Rel Liner  
 Color: Clear  
 Fold Style: C

36"

Folded Dim.

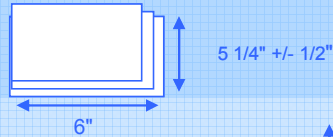

Packing: 250 pcs/ Shipper Carton

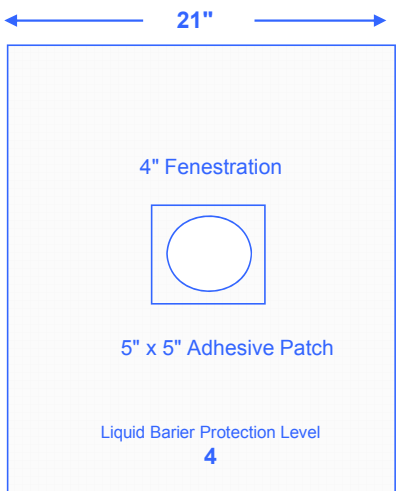
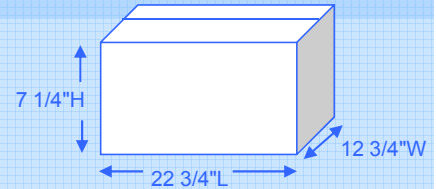

Suggested use: Pain Management Procedure

## Catalog Number: 6741

Material: Polyethylene Plastic 2.5 mil - Adhesive Fen /Paper Rel Liner  
 Color: Clear  
 Fold Style: C

30"

Folded Dim.

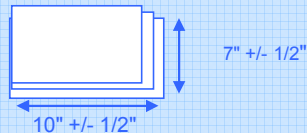

Packing: 250 pcs/ Shipper Carton

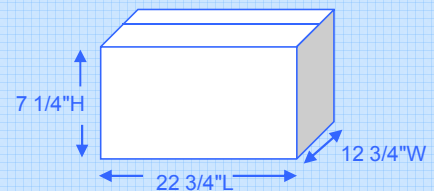

# Fenestrated Drapes with Adhesive Patch

Suggested use: Minor Procedure/ General Surgery / OR

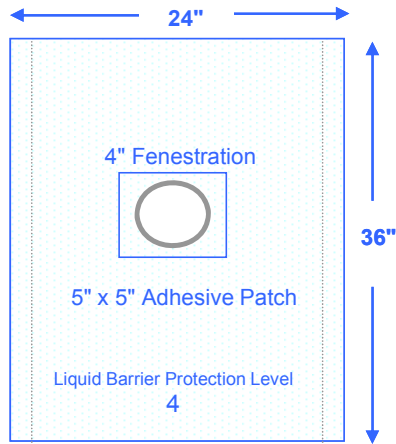

## Catalog Number: 6600

Material: White Tissue-Clear Polyethylene -White Tissue -- Adhesive Patch with Paper release Liner

Color: White

Fold Style: C

Folded Dim.

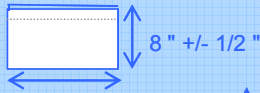

Packaging: 250 pcs/ Shipper Carton

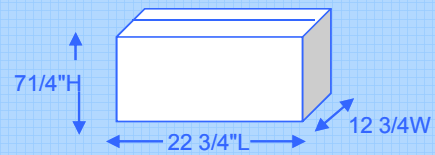

# Fenestrated Drape with Adhesive Strip / Labels

Suggested use: Pain Management Procedure

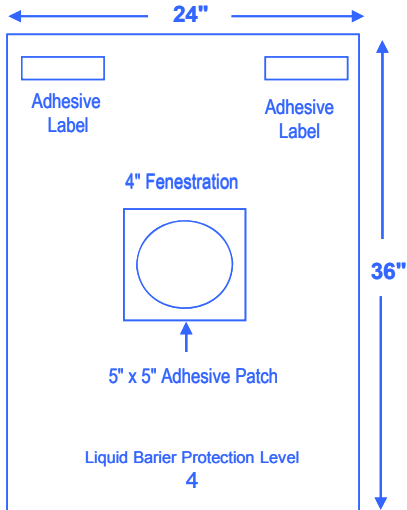

## Catalog Number: 6760

Material: Polyethylene Plastic 2.5 mil / 5" Adhesive Patch  
Two 1"x5" Adhesive Labels/Paper Release Liner  
Color: Clear  
Fold Style: C

Folded Dim

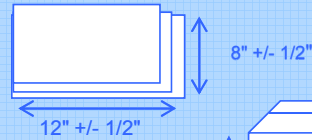

Packaging:  
6760 - 250 pcs /Shipper Carton 7 1/4"H

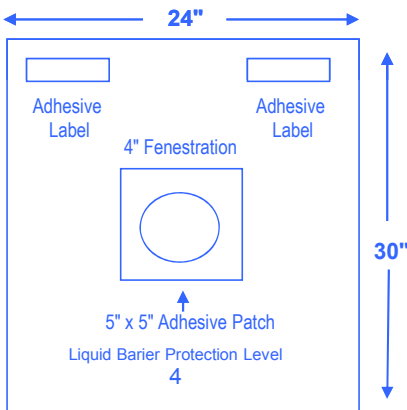
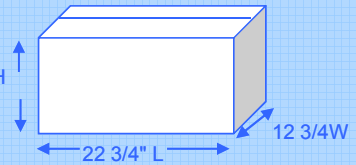

## Catalog Number: 6750

Material: Polyethylene Plastic 2.5 mil / 5" Adhesive Patch  
Two 1"x5" Adhesive Labels/Paper Release Liner  
Color: Clear  
Fold Style: C

Folded Dim

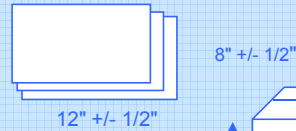

Packaging:  
6750 - 250 pcs /Shipper Carton

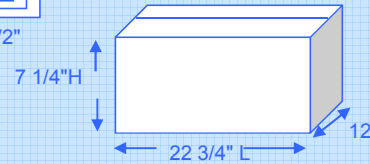

# Fenestrated Drapes with Adhesive Strip

Suggested use: Pain Management Procedure

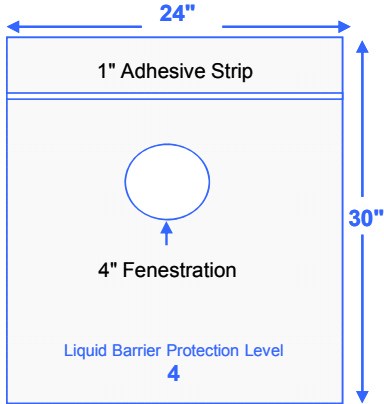

## Catalog Number: 6720

Material: Polyethylene Plastic 2.5 mil - Adhesive/Paper Release Liner  
 Color: Clear  
 Fold Style: W

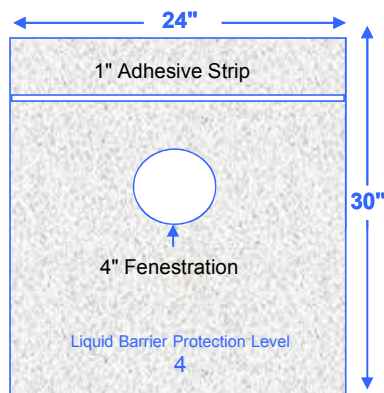
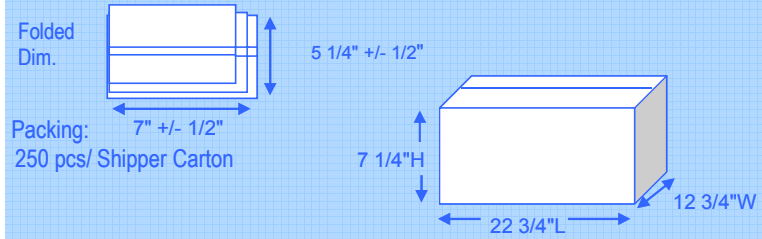

## Catalog Number: 6715

Material: Polyethylene Plastic, 2.5 mil - Adhesive/Paper Release Liner  
 Color: Translucent - Matt Finish  
 Fold Style: W

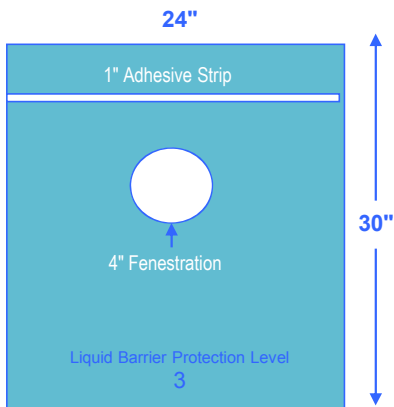
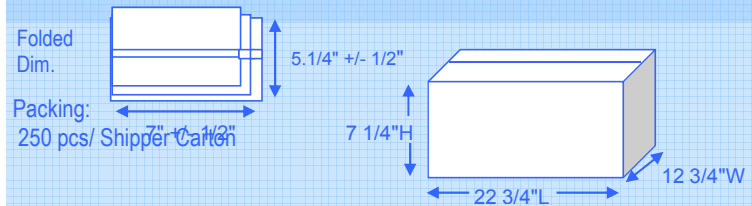

## Catalog Number: 6725

Material: Non-Woven - Adhesive/Paper Release Liner  
 Color: Blue  
 Fold Style: W

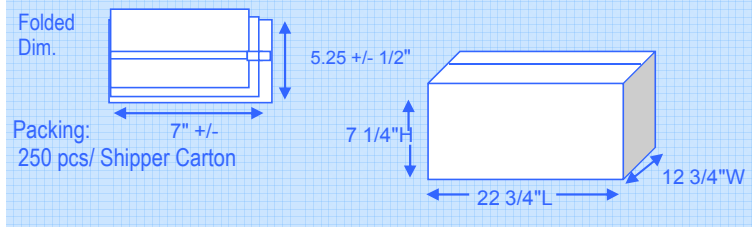

# Fenestrated Drapes with Adhesive Strip

Suggested use: Pain Management Procedure

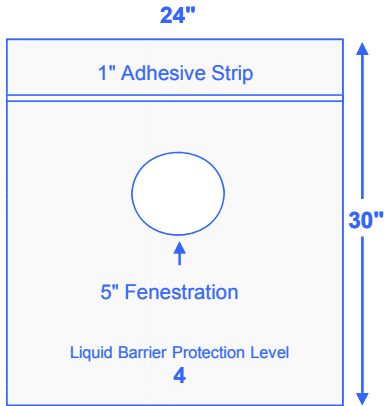

## Catalog Number: 6735

Material: Polyethylene Plastic 2.5 mil - Adhesive/Paper Release Liner  
Color: Clear  
Fold Style: W

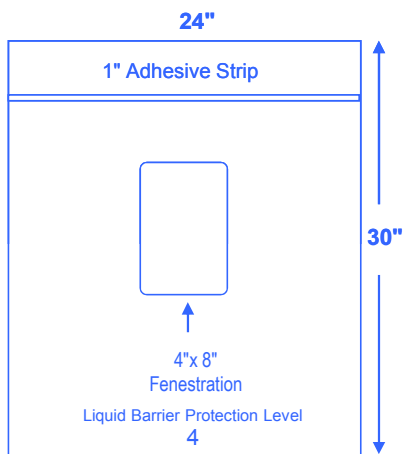
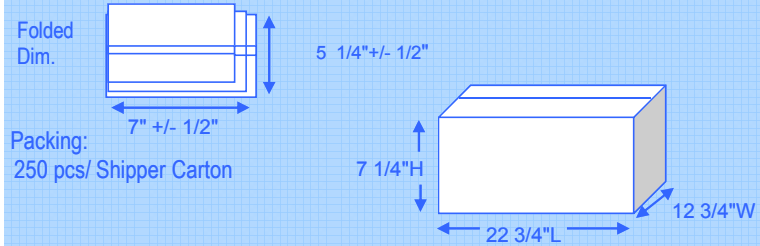

## Catalog Number: 6745

Material: Polyethylene Plastic 2.5 mil  
Color: Clear  
Fold Style: W

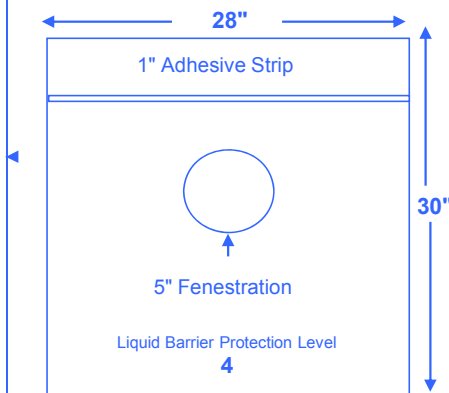
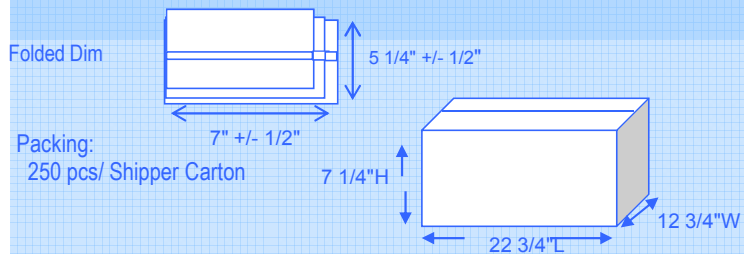

## Catalog Number: 6730

Material: Polyethylene Plastic, 2.5 mil - Adhesive/Paper Release Liner  
Color: Clear  
Fold Style: W

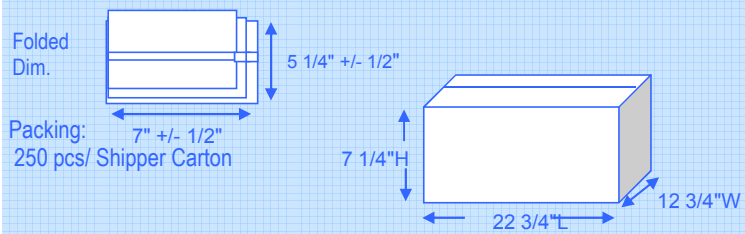



# U - Drape with U - Adhesive Strip

Suggested use: Minor Procedure/ General Surgery / OR

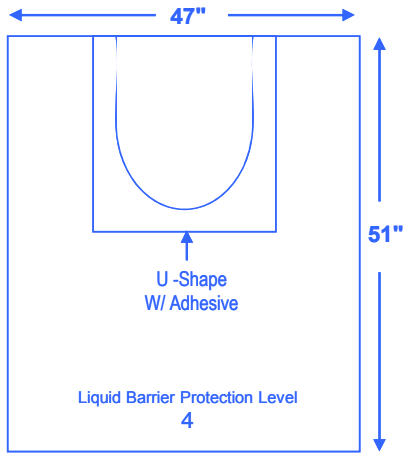

## Catalog Number: 6880

Material: Plastic 2.5 mil /  
Adhesive/Paper Release Liner  
Color: Translucent - Matt Finish

Folded Dim

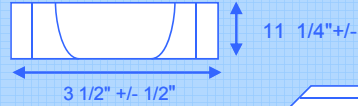

Packing:  
200 pcs/ Shipper Carton

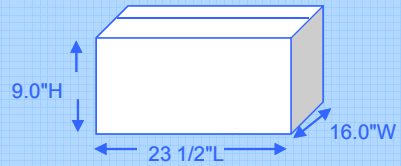

### Standard Drapes List

Catalog #	Drape Size (Inch)	Fenest. Size	Fenest. Shape	Patch (Inch)	Patch Release Liner Material	Strip	Strip Release Liner Material	Fold Style	Material	Material Weight / Thickness	Absorbent/ Repellent	Liquid Barrier Protection Level	Validated Sterilization Method	Case Pack - Each	Shipping Container Outer Dimension - Inches w x h x L
694	18 x 26	3	Round	N/A	None	None	N/A	W	Tissue-Poly-Tissue	17lb/.5mil/17lb	Absorbent-Impervious Absorbent	4	EO	300	15 x 7 x 20 1/4
695	18 x 26	N/A	None	N/A	None	None	N/A	W	Tissue-Poly-Tissue	17lb/.5mil/17lb	Absorbent-Impervious Absorbent	4	EO	500	13 3/4 x 10 x 26
6598	18 x 26	3"	Round	5 x 5	Paper	None	N/A	C	Tissue-Poly-Tissue	17lb/.5mil/17lb	Absorbent-Impervious Absorbent	4	EO	500	13 3/4 x 10 x 26
6600	24 x 36	4"	Round	5 x 5	Paper	None	N/A	C	White Tissue-Poly-WhiteTissue	17lb/.5mil/17lb	Absorbent-Impervious Absorbent	4	EO	250	12 3/4 x 7 1/4 x 22 3/4
6710	19 1/2 x 23	N/A	None	N/A	None	None	N/A	W	Scrim Reinforced Kaycel	N/A	Absorbent	0	EO	200	15 1/2 x 12 5/8 x 5 5/8
6711	19 1/2 x 23	N/A	None	N/A	None	None	N/A	W	Scrim Reinforced Kaycel	N/A	Absorbent	0	EO	500	13 3/4 x 10 3/4 x 20 1/4
6715	30 x 24	4"	Round	N/A	None	1	Paper	W	Translucent Plastic - Matt Finish	2.5mil	Repellent both sides	4	EO	250	12 3/4 x 7 1/4 x 22 3/4
6720	30 x 24	4"	Round	N/A	None	1	Paper	W	Clear plastic	2.5 Mil	Repellent both sides	4	EO	250	12 3/4 x 7 1/4 x 22 3/4
6725	30 x 24	4"	Round	N/A	None	1	Paper	W	Blue Non-woven	77.5 GSM	Absorbent-repellent	3	EO	250	12 3/4 x 7 1/4 x 22 3/4
6730	30 x 28	5	Round	N/A	None	1"	Paper	W	Clear Plastic	2.5 Mil	Repellent Both Sides / Impervious	4	EO	250	12 3/4 x 7 1/4 x 22 3/4
6735	30 x 24	5	Round	N/A	None	1"	Paper	W	Clear Plastic	2.5 Mil	Repellent Both Sides / Impervious	4	EO	250	12 3/4 x 7 1/4 x 22 3/4
6740	21 x 36	4	Round	5 x 5	Paper	None	N/A	C	Clear Plastic	2.5 Mil	Repellent Both Sides / Impervious	4	EO	250	12 3/4 x 7 1/4 x 22 3/4
6741	21 x 30	4	Round	5 x 5	Paper	None	N/A	C	Clear Plastic	2.5 Mil	Repellent Both Sides / Impervious	4	EO	250	12 3/4 x 7 1/4 x 22 3/4
6745	24 x 30	4 x 8	Rectangle	N/A	None	1"	Paper	W	Clear Plastic	2.5 Mil	Repellent Both Sides	4	EO	250	12 3/4 x 7 1/4 x 22 3/4
6750	24 x 30	4	Round	5 x 5	Paper	2 -1"x 5" Tabs	Paper	C	Clear Plastic	2.5 Mil	Repellent Both Sides	4	EO	250	12 3/4 x 7 1/4 x 22 3/4

## Standard Drapes List

Catalog #	Drape Size (Inch)	Fenest. Size	Fenest. Shape	Patch (Inch)	Patch Release Liner Material	Strip	Strip Release Liner Material	Fold Style	Material	Material Weight / Thickness	Absorbent/ Repellent	Liquid Barrier Protection Level	Validated Sterilization Method	Case Pack - Each	Shipping Container Outer Dimension - Inches w x h x L
6760	24 x 36	4	Round	5 X 5	Paper	2 -1"x 5" Tabs	Paper	C	Clear Plastic	2.5 Mil	Repellent Both Sides / Impervious	4	EO	250	12 3/4 x 7 1/4 x 22 3/4
6808	151/2 x 25	N/A	None	N/A	None	None	N/A	W	Blue SMS	48 GSM	Repellent Both Sides	3	EO	500	14 1/4 x 10 x 21 1/4
6811	15 1/2 x 25	3	Round	N/A	None	None	N/A	W	Blue SMS	N/A	Repellent	3	EO	500	14 1/4 x 10 x 21 1/4
6815	151/2 x 25	N/A	None	N/A	None	1	Paper	W	Blue SMS	N/A	Repellent	3	EO	500	14 1/4 x 10 x 21 1/4
6820	151/2 x 25	N/A	None	N/A	None	1	Paper	W	Blue SMS	N/A	Repellent	3	EO	500	14 1/4 x 10 x 21 1/4
6825	22 x 26	4 x 4	Square	5 x 5	Paper	None	N/A	C	SMS	48gsm	Repellent both sides	3	EO	250	9 3/4 x 8 1/4 x 26 3/4
6830	11 x 17	N/A	None	N/A	None	1.5" with 2" liner	Blue Plastic	Fan Fold	Translucent Plastic - Matt Finish	1.5mil	Repellent both sides	4	EO	200	6 3/4 x 6 x 19 1/4
6840	23 x 17	N/A	None	N/A	None	1.5" with 2" liner	Blue Plastic	Fan Fold	Translucent Plastic - Matt Finish	1.5mil	Repellent both sides	4	EO	200	6 3/4 x 6 x 19 1/4
6850	15 x 15	2.5	Round	5.5 x 5	Clear Plastic	None	N/A	C	Translucent Plastic - Matt Finish	1.5mil	Repellent both sides	4	EO	200	7 3/4 x 8 x 7
6855	15 x 15	2.5	Round w/ Slit	N/A	None	None	N/A	C	Translucent - Matt Finish	1.5 mil	Plastic - Repellent	4	EO	200	7 3/4 x 8 x 7
6861	22 x 25	N/A	None	N/A	None	None	N/A	Z	Laminated Non Woven	60 GSM	Absorbent - Repellent	4	EO	500	14 1/4 x 10 x 21 1/4
6870	22 x 25	2 1/2	Round	4" x 4"	Paper	None	N/A	Z	Laminated Non Woven	60 GSM	Absorbent - Repellent	4	EO	500	14 1/4 x 10 x 21 1/4
6880	47 x 51	U-Shape	U-Shape	U - Shape	Paper	U - Adhesiv	N/A	Folded	Translucent Plastic	2.5 Mil	Repellent both sides	4	EO	200	23 1/2 x 16 x 9
6890	51 x 51	3.875 x 4.875	Pocket	Pocket	None	None	N/A	Folded	Translucent Plastic - Matt Finish	50 GSM	Repellent both sides	4	EO	200	15 1/2 x 14 x 15
6935	19 1/2 x 28	N/A	None	N/A	None	None	N/A	W	Scrim Reinforced Kaycel	N/A	Absorbent	0	EO	500	13 3/4 x 10 3/4 x 20 1/4

## Standard Drapes List

Catalog #	Drape Size (Inch)	Fenest. Size	Fenest. Shape	Patch (Inch)	Patch Release Liner Material	Strip	Strip Release Liner Material	Fold Style	Material	Material Weight / Thickness	Absorbent/ Repellent	Liquid Barrier Protection Level	Validated Sterilization Method	Case Pack - Each	Shipping Container Outer Dimension - Inches w x h x L
6960	18 x 26	N/A	None	N/A	None	None	N/A	W	White Tissue-Poly-White Tissue	17lb/.5mil/17lb	Absorbent-Impervious Absorbent	4	EO	500	14 1/4 x 10 x 21 1/4
6970	18 x 26	3"	Round	N/A	None	None	N/A	W	Tissue-Poly-Tissue	17lb/.5mil/17lb	Absorbent-Impervious Absorbent	4	EO	500	14 1/4 x 10 x 21 1/4
6980	18 x 26	N/A	None	N/A	None	None	N/A	W	Tissue-Poly-Tissue	17lb/.5mil/17lb	Absorbent-Impervious Absorbent	4	EO	500	14 1/4 x 10 x 21 1/4
7114	18 x 16	N/A	None	N/A	None	None	N/A	W	Blue Tissue-Poly-White Tissue	17lb/.5mil/17lb	Absorbent-Impervious Absorbent	4	EO	750	14 1/4 x 10 x 21 1/4
3860A	18 x 16	5/8"	Round	N/A	None	None	N/A	W	Blue Tissue-Poly-Tissue	17lb/.5mil/17lb	Absorbent-Impervious Absorbent	4	EO	750	14 1/4 x 10 x 21 1/4

# AAMI LIQUID BARRIER CLASSIFICATION

## **Level 1      Drapes**

Describes surgical gowns, other protective apparel, surgical drapes, and drapes accessories that demonstrate the ability to resist liquid penetration in a laboratory test, AATCC 42 (Water resistance: Impact penetration test).

## **Level 2      Drapes**

Describes surgical gowns, other protective apparel, surgical drapes, and drapes accessories that demonstrate the ability to resist liquid penetration in two laboratory tests, AATCC 42 (Water resistance: Impact penetration test) and AATCC 127 ( Water resistance: Hydrostatic pressure test).

## **Level 3      Drapes**

Describes surgical gowns, other protective apparel, surgical drapes, and drapes accessories that demonstrate the ability to resist liquid penetration in two laboratory tests, AATCC 42 (Water resistance: Impact penetration test) and AATCC 127 ( Water resistance: Hydrostatic pressure test). For Level 3, the test criterion for AATCC 127 is set at a higher value than for Level 2.

## **Level 4      Drapes**

Describes surgical drapes, and drapes accessories that demonstrate the ability to resist liquid penetration in a laboratory test, ASTM 1670 (Standard test method for resistance of materials used in protective clothing to penetration by synthetic blood).

Level	Test	Result
1	AATCC 42:2000	≤ 4.5 g
2	AATCC 42:2000 AATCC 127:1998	≤ 1.0 g ≥ 20 cm
3	AATCC 42:2000 AATCC 127:1998	≤ 1.0 g ≥ 50 cm
4	Gowns: ASTM F1671:2003 Drapes: ASTM F1670:2003	Pass Pass

**Table 1: Classification of barrier performance of surgical gowns, other protective apparel, surgical drapes and drape accessories.**

The more stringent tests of this standard, ASTM F1670 , involves the use of body fluid simulants according to time and pressure protocols that have been found to discriminate a higher level barrier performance in the laboratory setting.

The less stringent tests, AATC 42 and AATC 127, involves the use of indirect (splash or spray) and direct contact with water according to time and pressure protocols.

The classification system is intended to set a common foundation for the different levels of barrier protection available but does not take into account potential variations in specific procedures and techniques used in health care facilities. The end user is the ultimate judge of the appropriateness of the barrier level required, based on experience and the potential or known exposure risks.

## AAMI LIQUID BARRIER CRITICAL ZONE EXPLANATION

### **Critical Zones**

The barrier requirements for the design and construction of surgical drapes, and drape accessories are based on the anticipated location and degree of liquid contact, given the expected condition of use.

The critical zones includes those areas where direct contact with blood , body fluids and OPIM ( Other Potential Infectious Material) is most likely to occur, although areas outside the critical zone can be inadvertently splashed or sprayed as well.

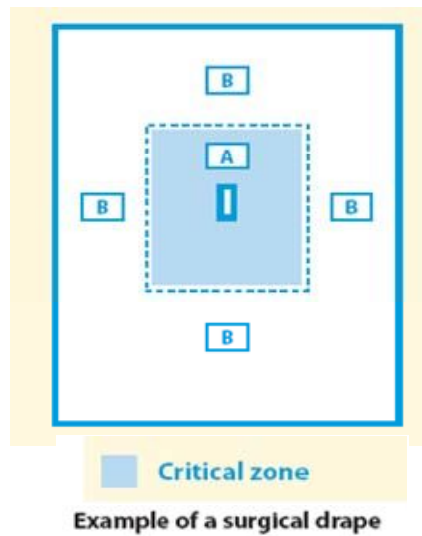

### **Surgical Drapes**

Because of the variation in patient size, patient positioning, and draping technique, as well as the possible expansion of the surgical site or field during the procedure, the entire drape (areas A and B) is expected to meet at least the minimum level of barrier performance (Level 1). The critical zone of a surgical drape comprises area A.

---

## FLAMMABILITY COMPLIANCE

Meets Flammability Standard 16 CFR 1610, Class 1.



Hospital Disposables  
75 Arkay Drive  
Hauppauge, NY 11788  
Tel: 631-435-4711  
Fax: 631-435-2849

### Biocompatibility Summary Report

Device Materials: Polyethylene Film - Clear  
Embossed Polyethylene Film-Translucent Matt Finish  
Non-Woven  
Laminated Non-Woven  
Tissue-Poly-Tissue  
Scrim Reinforced Kaycel  
SMS

Device Part Number (s): Various – Refer to Standard Drape List

Description: Busse Surgical Drapes

Following Biocompatibility test(s) were performed on finished, sterile device in accordance with ISO 10993-1 requirements:

- **Sensitization**  
Kligman Maximization Test
- **Irritation**  
Intracutaneous Injection Test
- **Acute Systemic Toxicity**  
Systemic Injection Test  
Rabbit Pyrogen Test
- **Cytotoxicity**  
L929 Mem Elution Test

The test results demonstrate the material used meet the ISO 10993-1 requirements for a limited contact externally communicating device with indirect blood contact.

Quality Assurance Department  
April 8, 2009

## MATERIAL SAFETY DATA SHEET (MSDS)

To request MSDS, please email us at [rpatel@busseinc.com](mailto:rpatel@busseinc.com), call our safety coordinator @ 1800-645-6526 x 260, or complete this short information-gathering form fax it to 631-435-2849.

First name

Last name

Title

Company

Address

City

State

Email

Telephone

Fax

Item Number

Question



## Kit Manufacturer Questionnaire

### PRODUCT LABELING

Product Description	Surgical Drape
Direct Manufacturer	<input checked="" type="checkbox"/> Yes <input type="checkbox"/> No      Country : USA
Is individual unit labeled with the country of origin?	<input type="checkbox"/> Yes <input checked="" type="checkbox"/> No      Shelf Life:
Is product expiration dated?	<input type="checkbox"/> Yes <input checked="" type="checkbox"/> No
Does labeling state "Do Not Re-Sterilize"?	<input type="checkbox"/> Yes <input checked="" type="checkbox"/> No
Is Product labeled with specific storage conditions?	<input type="checkbox"/> Yes <input checked="" type="checkbox"/> No
If yes, please specify storage conditions:	
Is product labeled Pyrogen Free?	<input type="checkbox"/> Yes <input type="checkbox"/> No <input checked="" type="checkbox"/> N/A
Comments	

### STERILITY AND PACKAGING DATA

How is product packaged?	<input type="checkbox"/> Individual <input checked="" type="checkbox"/> Bulk <input type="checkbox"/> Both
Does product need to remain in its innermost sealed packaging?	<input type="checkbox"/> Yes <input checked="" type="checkbox"/> No
comments on innermost sealed packaging:	
Packaging format ( ie items per box, boxes in case, item bulk)	Various Formats ( depends on size and quantity)
Is product in a foil package?	<input type="checkbox"/> Yes <input checked="" type="checkbox"/> No
How is product supplied to OEM?	<input type="checkbox"/> Sterile <input checked="" type="checkbox"/> Non-Sterile <input type="checkbox"/> Both
If sterile, what is the Sterility Assurance Level (Sal)?	<input type="checkbox"/> 10 <sup>-6</sup> <input type="checkbox"/> 10 <sup>-3</sup> <input checked="" type="checkbox"/> NA
If sterile, what sterilization method was used?	<input type="checkbox"/> Radiation <input type="checkbox"/> 100%EtO <input type="checkbox"/> Other
If the sterilization method is Radiation, what is the minimum and maximum dosage?	Min:      kGy      Max:      kGy
Comments	

## REGULATORY DATA

What is the intended use of this product?	Drapes are designed to be used in surgical procedures.
Is the product supplied as a:	<input type="checkbox"/> Drug <input checked="" type="checkbox"/> Medical Device (Listing #A100346 ) <input type="checkbox"/> Non- Medical Device
Which of the following apply:	<input checked="" type="checkbox"/> 510 (k) # KB43496, K082297, K083424 <input type="checkbox"/> NDA <input type="checkbox"/> PMA <input type="checkbox"/> Exempt <input type="checkbox"/> Pre-Amendment <input type="checkbox"/> Non-Medical
If a medical device, what FDA classification is it?	<input type="checkbox"/> Class I <input checked="" type="checkbox"/> Class II <input type="checkbox"/> Class III
If a medical device, what European MDD Class is it?	<input checked="" type="checkbox"/> Class I <input type="checkbox"/> Class Is <input type="checkbox"/> Class Im <input type="checkbox"/> Class Ila <input type="checkbox"/> Class Iib <input type="checkbox"/> Class III
Is product CE marked?	<input type="checkbox"/> Yes <input checked="" type="checkbox"/> No
If a drug, is it a scheduled drug?	<input type="checkbox"/> Yes <input type="checkbox"/> No <input checked="" type="checkbox"/> NA
Is product considered hazardous by the DOT, 49CFR172.101, while in transit?	<input type="checkbox"/> Yes <input checked="" type="checkbox"/> No
Does product have MSDS?	<input checked="" type="checkbox"/> Yes <input type="checkbox"/> No <span style="float: right;">MSDS Section</span>
Comments	

## ENVIRONMENTAL, HEALTH AND SAFETY FACTORS

Is the product a chemical, chemical reagent or a drug?	<input type="checkbox"/> Yes <input checked="" type="checkbox"/> No
If yes, then is the product or its components listed on the TSCA chemical inventory?	<input type="checkbox"/> Yes <input type="checkbox"/> No <span style="float: right;">N/A</span>
Does this product contain and/or is it manufactured or sterilized with ozone depleting agents as defined in FED. Register 40 CFR Part 82 Appendix A to Subpart A?	<input type="checkbox"/> Class I (ex CFSs- Freon, Halon) <input type="checkbox"/> Class II ( ex HCFCs) <input checked="" type="checkbox"/> NO
Does the product require warning under California Proposition 65?	<input type="checkbox"/> Yes <input checked="" type="checkbox"/> No
If yes, does the product contain:	<input type="checkbox"/> Carcinogen <input type="checkbox"/> Reproductive Toxicant <input type="checkbox"/> Both <input checked="" type="checkbox"/> Neither
Does the product contain the following?	<input type="checkbox"/> Silicone Rubber <input type="checkbox"/> DEHP <input type="checkbox"/> PVC <input checked="" type="checkbox"/> None
Does the product and/or packaging contain "heavy metals", e.g. Pb, Hg, Cd, Cr <sup>6</sup> , the combined totals of which exceeds 100ppm?	<input type="checkbox"/> Yes <input checked="" type="checkbox"/> No
Are this product's raw materials derived directly from animal materials?	<input type="checkbox"/> Yes <input checked="" type="checkbox"/> No
Does product, including adhesives contain Natural Rubber Latex?	<input type="checkbox"/> Liquid <input type="checkbox"/> Dry Gum <input checked="" type="checkbox"/> None
If the product contains latex, is it intended to or likely to contact the patient or user?	<input type="checkbox"/> Yes <input type="checkbox"/> No <span style="float: right;">N/A</span>
Does the packaging, including adhesives contain Natural Rubber Latex?	<input type="checkbox"/> Yes <input checked="" type="checkbox"/> No
If yes, which packaging layer contains the Natural Rubber Latex?	<input type="checkbox"/> Primary <input type="checkbox"/> Secondary <input type="checkbox"/> Tertiary

**ENVIRONMENTAL, HEALTH AND SAFETY FACTORS** (Continued from page 2)

Does the product contain Volatile Organic Compounds?	<input type="checkbox"/> Yes <input checked="" type="checkbox"/> No
If yes, what percentage?	
Is the product a liquid solidifier or sanitizer?	<input type="checkbox"/> Yes <input checked="" type="checkbox"/> No
If yes, is it certified by CalEPA and licensed for sale in the State of California?	<input type="checkbox"/> Yes <input type="checkbox"/> No N/A
Comments	

**PHYSICAL DATA**

Specific Materials of Construction:	Polyethylene Film - Clear Embossed Polyethylene Film - Translucent Matt Finished Non-Woven Laminated Non-Woven Tissue-Poly-Tissue Scrim Reinforced Kaycel SMS
Product size:	Various ( Refer to Standard Drape List)
Comments:	

**STERILIZATION COMPATIBILITY**

Acceptable Re-Sterilization Parameters when Supplied as Sterile

Is Re-Sterilization Acceptable?	<input checked="" type="checkbox"/> Yes <input type="checkbox"/> No One Time
Gamma Radiation 29-45 kGy?	<input type="checkbox"/> Yes <input checked="" type="checkbox"/> No
Is product vacuum sensitive?	<input type="checkbox"/> Yes <input checked="" type="checkbox"/> No
100% EtO?	<input type="checkbox"/> Yes <input type="checkbox"/> No
Comments on EtO Sterilization Compatibility:	

Acceptable Sterilization Parameters when Supplied as Non-Sterile

Gamma Radiation 29-45 kGy?	<input type="checkbox"/> Yes <input checked="" type="checkbox"/> No
Is product vacuum sensitive?	<input type="checkbox"/> Yes <input checked="" type="checkbox"/> No
100% EtO?	<input checked="" type="checkbox"/> Yes <input type="checkbox"/> No
Comments on EtO Sterilization Compatibility:	
If OEM would need to run product through their sterilization cycle twice, for which cycle would this be acceptable, irrespective of EtO residuals?	<input checked="" type="checkbox"/> EtO twice <input type="checkbox"/> Gamma Twice <input type="checkbox"/> No Double Sterilization

**GENERAL COMMENTS**

Comments	
----------	--

**Build -a- Drape**  
**Material Selection Page**

<p align="center"><b>M 1</b>  <b>Laminated Non -Woven</b>  <b>Absorbent / Repellent</b></p>	<p align="center"><b>M17</b>  <b>Non - Woven</b>  <b>Absorbent / Repellent</b></p>	<p align="center"><b>M2 &amp; M3</b>  <b>SMS</b>  <b>Repellent</b></p>
<p><b>LEVEL 4</b></p> <p><u>Roll Size:</u>  W: 22"  L: 15" to 36"</p> <p>Adhesive Strip orientation :  Vertical</p>	<p><b>LEVEL 3</b></p> <p><u>Roll Size:</u>  W: 30"  L: 15" to 36"</p> <p>Adhesive Strip orientation :  Horizontal</p>	<p><b>LEVEL 3</b></p> <p><u>Roll Size:</u>  M3 - W: 15 1/2"  M2 - W: 26"  L: 15" to 36"</p> <p>Adhesive Strip orientation :  Vertical</p>
<p align="center"><b>M 4</b>  <b>White Tissue -Poly -Wht. Tissue</b>  <b>Absorbent/Impervious/Absorbent</b></p>	<p align="center"><b>M5</b>  <b>Blue Tissue -Poly -Wht. Tissue</b>  <b>Absorbent/Impervious/Absorbent</b></p>	<p align="center"><b>M6, M11 &amp; M12</b>  <b>Clear Plastic - 2.5 Mil</b>  <b>Repellent</b></p>
<p><b>LEVEL 4</b></p> <p><u>Roll Size:</u>  M4 - W: 18"  L: 15" to 36"</p> <p>Adhesive Strip orientation :  Vertical</p>	<p><b>LEVEL 4</b></p> <p><u>Roll Size:</u>  W: 18"  L: 15" to 36"</p> <p>Adhesive Strip orientation :  Vertical</p>	<p><b>LEVEL 4</b></p> <p><u>Roll Size:</u>  M6 - W: 21"  M11 - W: 24"  M12 - W: 30"  L: 15" to 36"</p> <p>Adhesive Strip orientation :  Vertical</p>
<p align="center"><b>M7</b>  <b>Translucent Plastic 2.5 Mil</b>  <b>Repellent</b></p>	<p align="center"><b>M 8</b>  <b>Scrim Reinforced Kaycel</b>  <b>Absorbent</b></p>	<p align="center"><b>M9, M13 &amp; M14</b>  <b>Translucent Plastic 1.5 Mil</b>  <b>Repellent</b></p>
<p><b>LEVEL 4</b></p> <p><u>Roll Size:</u>  W: 30"  L: 15" to 36"</p> <p>Adhesive Strip orientation :  Horizontal</p>	<p><b>LEVEL 0</b></p> <p><u>Roll Size:</u>  W: 19 1/2"  L: 15" to 36"</p> <p>Adhesive Strip orientation :  N/A</p>	<p><b>LEVEL 4</b></p> <p><u>Roll Size:</u>  M9 - W: 11"  M13 - W:15"  M14 - W: 23"  L: 17"</p> <p>Adhesive Strip orientation :  Vertical</p>

**Build-a-Drape**  
**Material Selection Page 2**

<b>M10</b> White Tissue/Blue Polyp/White Tissue Absorbent/Impervious/Absorbent	<b>M15</b> Scrim Reinforced Kaycel & Clear Poly Poly Absorbent / Impervious	<b>M16 &amp; M18</b> White Tissue -Poly -White Tissue Absorbent/Impervious/Absorbent
<p>LEVEL 4</p> <p><u>Roll Size:</u></p> <p>W: 18" L: 15" to 36"</p> <p>Adhesive Strip orientation : Vertical</p>	<p>LEVEL</p> <p><u>Roll Size:</u></p> <p>W: 21" L: 15" to 36"</p> <p>Adhesive Strip orientation : Horizontal</p>	<p>LEVEL 4</p> <p><u>Roll Size:</u></p> <p>M16 - W: 24" M18- W: 18" L: 15" to 36"</p> <p>Adhesive Strip orientation : Vertical</p>

# Build-a-Drape

## Fenestration Selection Page

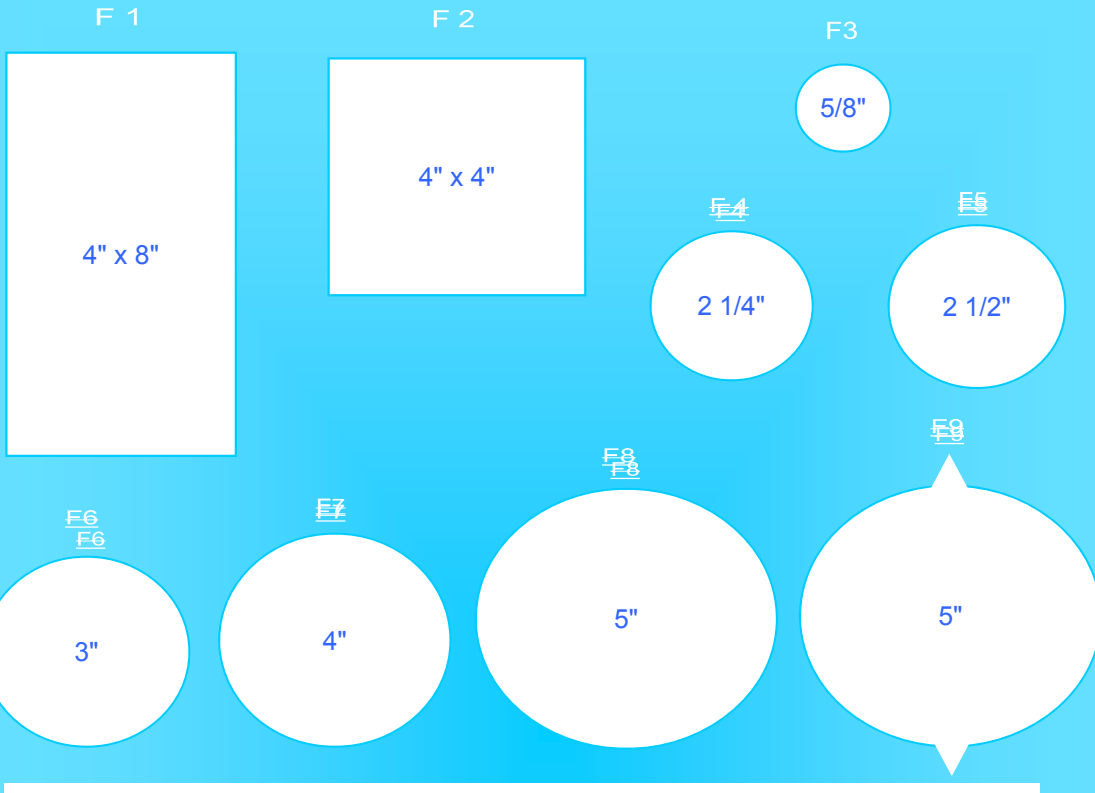

## Fenestration with Adhesive

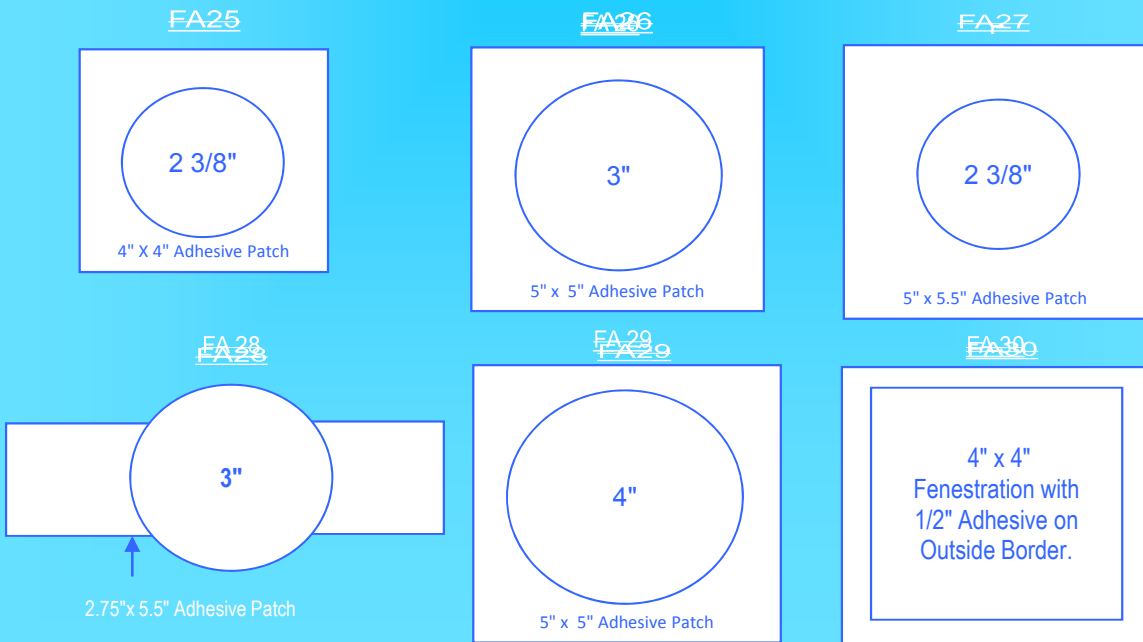

# Build-a-Drape

## ADHESIVE STRIP

Paper Release  
Liner



A 01

Paper Release  
Liner



A 02

Blue Plastic  
Release Liner



A 03

Blue Wde  
Plastic Release

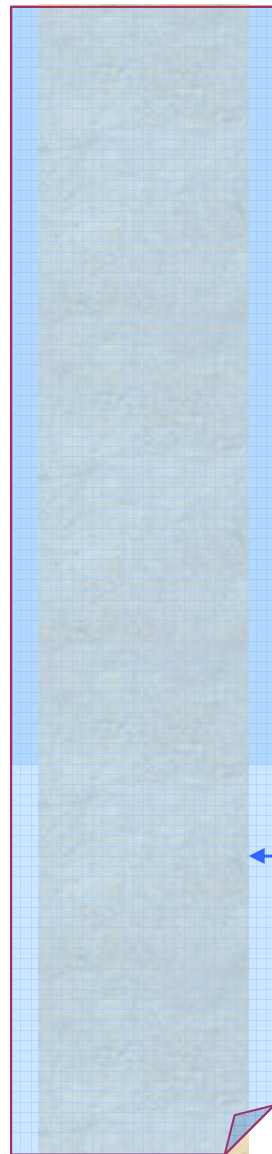

A 04

	A01	A02	A03	A 04
Adhesive Width:	1/2"	3/4"	1 1/2"	4"
Release Liner:	1"	1"	2"	5 1/2"

# Build-a-Drape

## ADHESIVE LABEL

Paper Release  
Liner

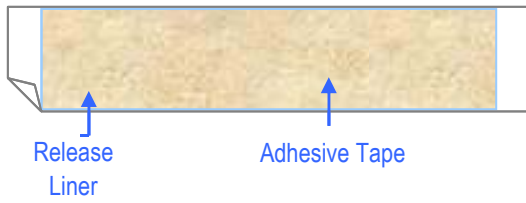

**LL 1**



**LR 1**

Adhesive Strip: 1" x 4 1/2"

Release Liner: 1" x 5"



# Build-a-Drape

## Fold Style - W

Step # 1

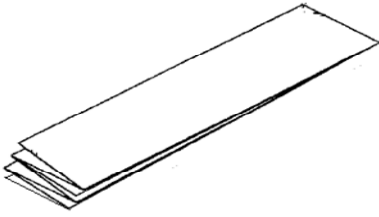

Step # 2

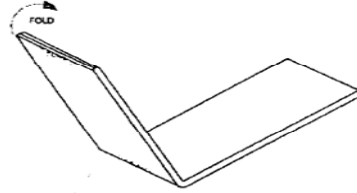

Step # 3

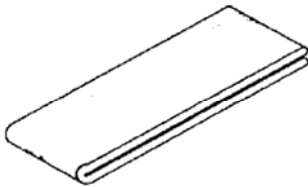

Step # 4

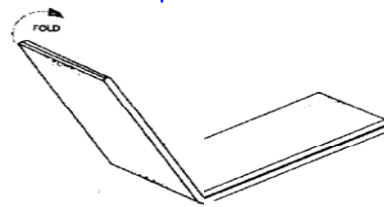

---

## Fold Style - C

Step # 1

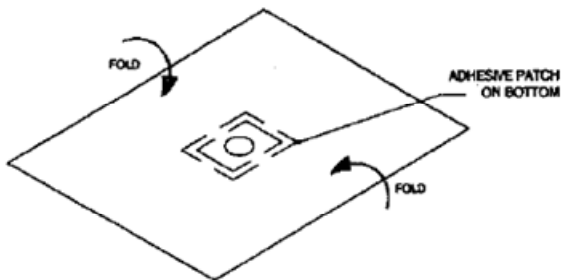

Step # 2

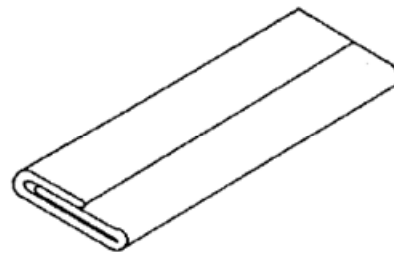

Step # 3

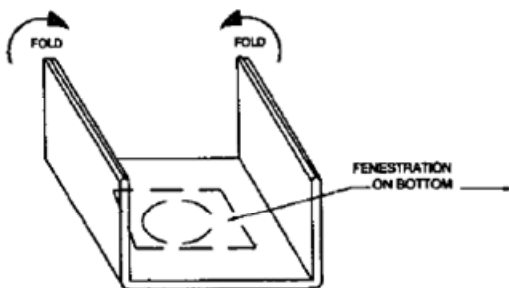

Step # 4



# Build-a-Drape

## Fold Style - Z

Step # 1

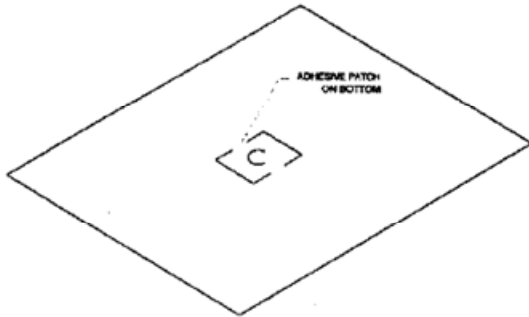

Step # 2

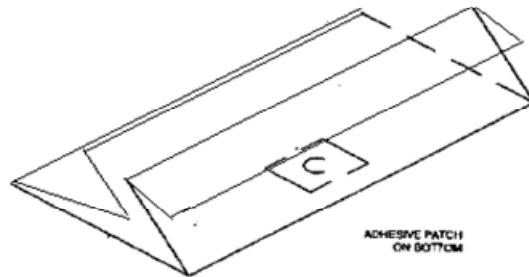

Step # 3

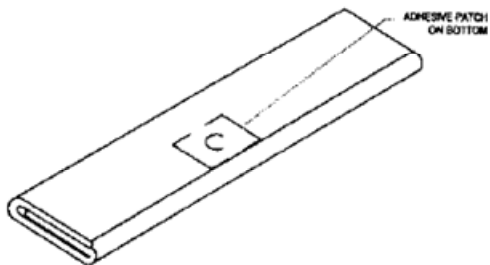

Step # 4



# Build-a-Drape

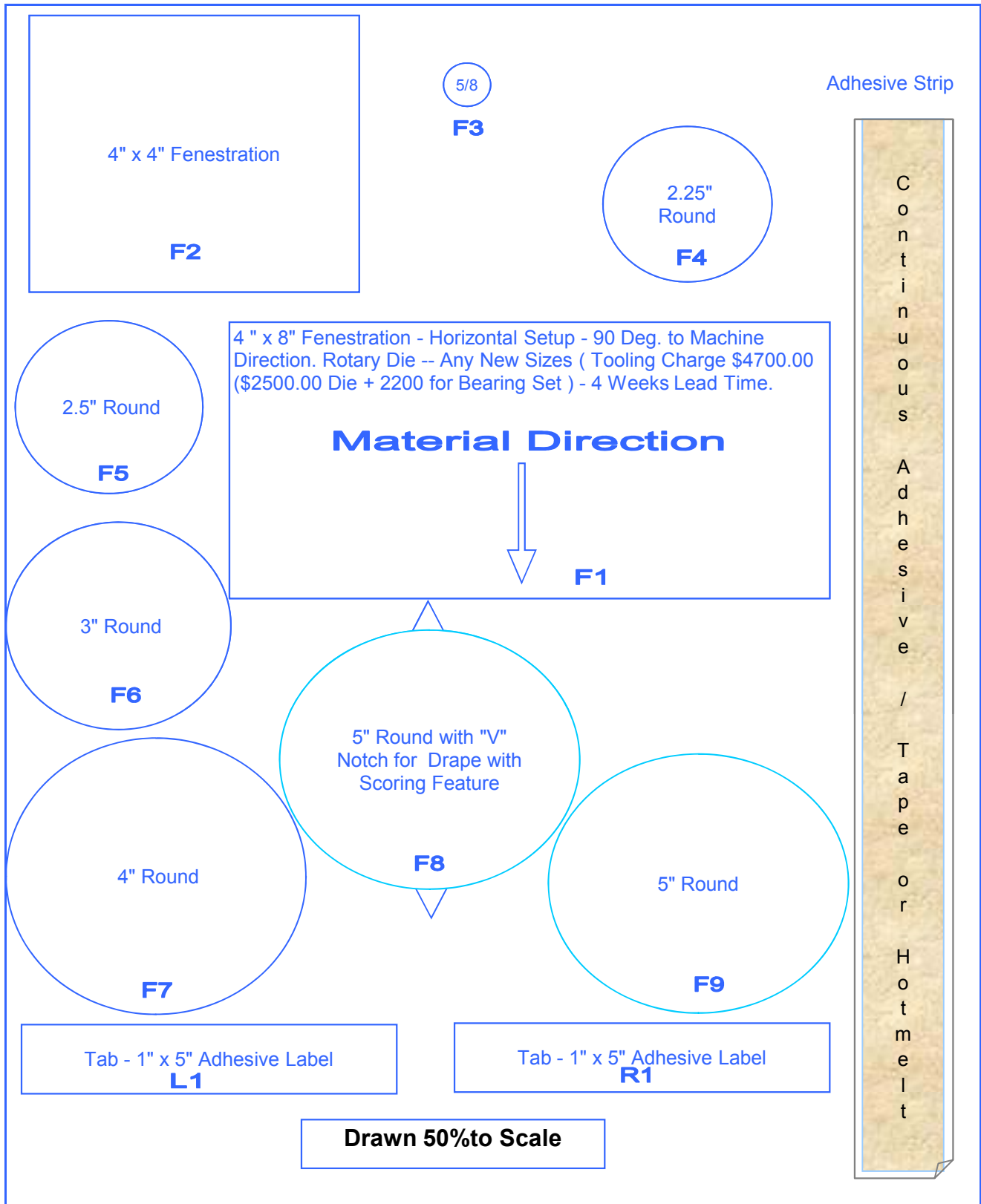

## Build-a-Drape

### Optional Fenestration Capabiltiy

4 " x 6" or 6" x 4" Fenestration - Horizontal or Vertical Setup - 90 Deg. to Machine Direction.  
Stamp Die -- Any Special Sizes Maximum 6" Square Rectangle, Round or smaller size  
(Tooling Charge \$2500.00) - 4 Weeks Lead Time for new Tooling Die.

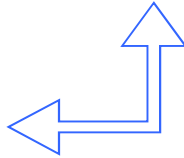

**F13?**

**Drawn 50% to Scale**

# Build-a-Drape

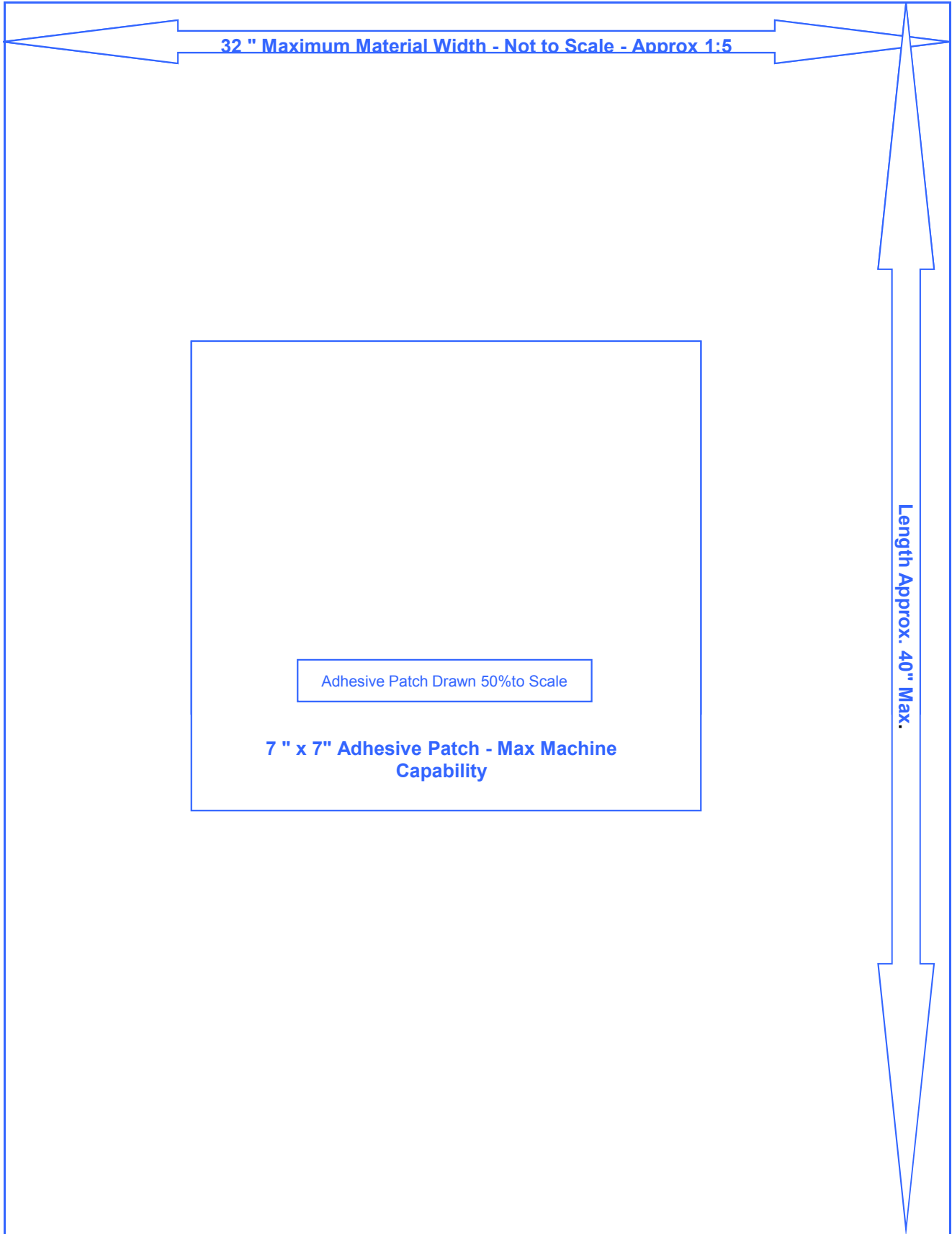

# Build-a-Drape

## Build A Drape Work Sheet

### Fenestration Placement Selection

Please Select One

Center

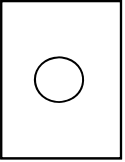

Off Center

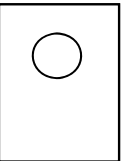

1" x 5" Label Selection

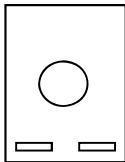

None

### Adhesive Strip Placement Selection

Please Select One

Horizontal

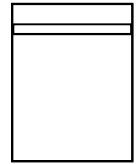

Vertical

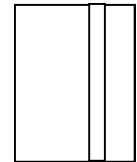

1" x 5" Label Selection

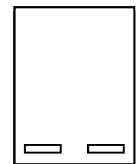

None

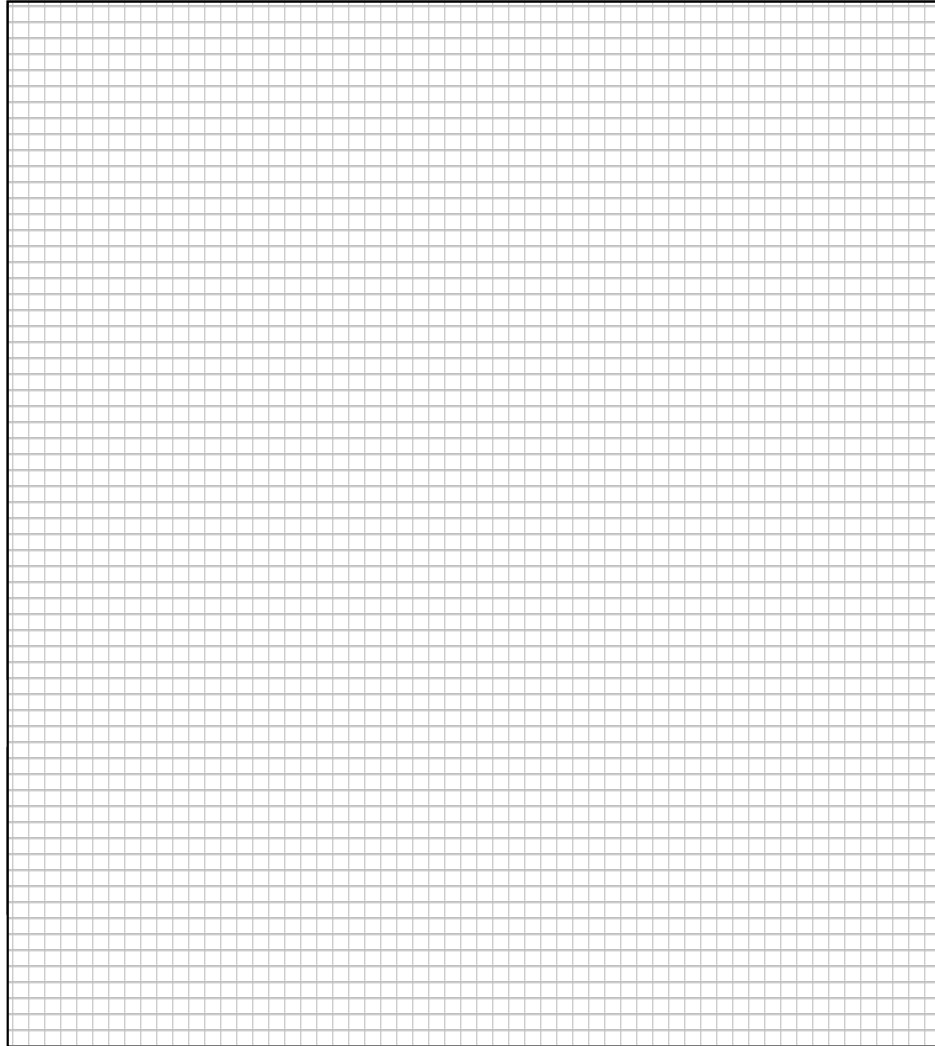

Procedure: \_\_\_\_\_ How will it be used ? \_\_\_\_\_

Size: \_\_\_\_\_ L \_\_\_\_\_ W Material #: \_\_\_\_\_ <sup>1</sup>Fenestration # \_\_\_\_\_ <sup>1</sup>Adhesive Strip: \_\_\_\_\_

Label: R \_\_\_\_\_ L \_\_\_\_\_ Fenestration with Adhesive: \_\_\_\_\_ Fold Style: \_\_\_\_\_

<sup>1</sup>If Adhesive Strip or Fenestration is Not Required write/ type N/A in the field.

### Customer Info:

Company Name: \_\_\_\_\_

Contact: \_\_\_\_\_ Estimated Volume: \_\_\_\_\_

Phone: \_\_\_\_\_ Fax: \_\_\_\_\_

Email: \_\_\_\_\_ Web Address: \_\_\_\_\_

Busse Fax: 631-435-4721

Phone: 1800-645-6526

Email: [mail@busseinc.com](mailto:mail@busseinc.com)

Web Address: [www.busseinc.com](http://www.busseinc.com)

Code Matrix  
For Busse Internal Use

**Fenestration**

<b>Fenestration Code</b>	<b>Size</b>	<b>Description</b>
F01	4 x 8	Rectangle
F02	4 x 4	Square
F03	5/8	Round
F04	2.25	Round
F05	2.50	Round
F06	3	Round
F07	4	Round
F08	5	Round
F09	5	Round with "V" Notch

**Pleater / Fold**

<b>Pleater Code</b>	<b>Style</b>	<b>Size of Drape (Width) Inch</b>
P01	W	30,22,15,18,21 & 24 (without adhesive patch)
P02	Z	22
P03	C	15
P04	C	18
P05	C	21
P06	C	24

**Patch - Adhesive**

<b>Code</b>	<b>Internal #</b>	<b>Material</b>	<b>Size - Adhesive Strip / Release Liner</b>
Z01	6980A	5" Wide White Adhesive w 1/4" Extended Liner (5.5 total width)	2.75-5.5
Z02	4320F	Tape Adhesive Wide Blue Plastic Release Liner	4 - 5
Z03	6870B	4" Wide Adhesive Roll w/Extended Liner (4 total width)	3.5 - 4

**Material**

<b>Code</b>	<b>Internal #</b>	<b>Material</b>	<b>Width(s) (Inch)</b>
M01	4330A	Laminated Non-Woven - Absorbent/ Repellent	22
M02	6825A	SMS Non Woven, Blue	26
M03	6800A	SMS Blue Non Woven, Blue	15.5
M04	5116A-1 / 6966A/ 5116A-1	White Tissue-Polye-White Tissue Absorbent/ Impervious/ Absorbent	18
M05	6962-1 / 6966A / 5116A-1	Blue Tissue-Polye-White Tissue- Absorbent/ Impervious/ Absorbent	18
M06	6342-1	Clear Plastic 2.5 Mil / Repellent	21
M07	6715A	Translucent Plastic (2.5 Mil) - Repellent - Matt Finish	30
M08	6930A	Scrim Reinforced Kaycel - Blue	19 1/2
M09	4300A	Translucent Plastic (1.5 Mil) Repellent - Matt Finish	11
M10	5116A-1 / 6950F/ 5116A-1	White Tissue-Blue Polyp-White Tissue Absorbent/ Impervious/ Absorbent	18
M11	6760B	Clear Plastic (2.5 Mil) - Repellent	24
M12	6710A-2	Clear Plastic (2.5 Mil) - Repellent	30
M13	4320A	Translucent Plastic (1.5 Mil) Repellent - Matt Finish	15
M14	4310A	Translucent Plastic (1.5 Mil) Repellent - Matt Finish	23

Code Matrix  
For Busse Internal Use

M15	6341/6342-1	3" Kaycel Strip/Clear Poly	21
M16	6600A / 6600B / 6600A	White Tissue/Polye (.5 mil)/White Tissue	24
M17	6725A	Blue Non Woven, Blue	30
M18	6961-1 / 6966A / 6961-1	White Tissue/polye(.5mil)/White Tissue	18

**Adhesive Strip**

Code	Internal #	Material	Size - Adhesive Strip / Release Liner
A01	6800F	Hot Melt Adhesive Paper Release Liner	1/2 - 1"
A02	6700F-4	Tape Adhesive Paper Release Liner	3/4 - 1
A03	4300F	Tape Adhesive Blue Plastic Release Liner	1 1/2 - 2
A04	4320F	Tape Adhesive Wide Blue Plastic Release Liner	4 - 5

**Special Feature**

Code	Internal #	Description
S01	S01	Slit
S02	S02	Score
S03	6/667	Glue with Strip
S04	6910L	Direction Label ( Fen or Opening)
S05	6830P-2	2.25" 60# White Text Paper

**Labeler (Adhesive Tabs)**

Code	Internal #	Location of Tabs	Size - Adhesive Strip / Release Liner
L01	6760A	Paper LEFT Release Liner with Adhesive Tape	1" x 4 1/2" / 1" x 5"
L02	6760A	Paper RIGHT Release Liner with Adhesive Tape	1" x 4 1/2" / 1" x 5"
L03	6760A-6760A	Left Release Liner w/Tape/Right Release Liner w/Tape	1" x 4 1/2" / 1" x 5"

**Key/Change Over Times:**

F = Fenestration	1.5 Hrs.
P = Folder/Pleater	0.5 Hrs.
Z = Patch	(included in Fenestration)
M = Material	0.25 Hrs.
A = Adhesive/Tape Strip	0.25 Hrs.
S = Special Feature	1.0 Hrs.
L = Labeler	1.0 Hrs.





*For all your draping requirements or questions please contact us . Our professional staff is available to assist you with your needs.*

We give you three easy ways to order:

- Fill out the order form and fax it to us
- Call us
- Email us

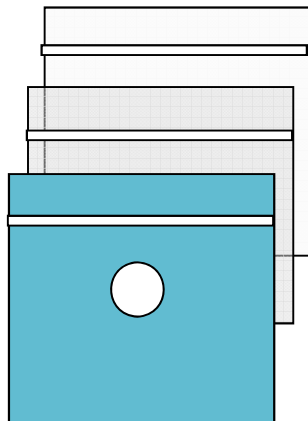

## **Busse Hospital Disposables**

Street Address: 75 Arkay Drive  
Address: PO Box 11067  
Hauppauge, NY 11788

Phone: 800-645-6526  
Fax (631) 435-4721

[www.busseinc.com](http://www.busseinc.com)